



Affirm™ breast biopsy guidance system

User Guide

MAN-03209 Revision 005

Affirm™

Breast Biopsy Guidance System

HOLOGIC®



Breast Biopsy Guidance System

User Guide

For Software Version 1.7

Part Number MAN-03209

Revision 005

January 2015

Technical Support:

USA: +1.877.371.4372

Europe: +32.2.711.4690

Asia: +852.37487700

All Other: +1.781.999.7750

HOLOGIC®

Corporate Headquarters

35 Crosby Drive,
Bedford, MA 01730-1401 USA
Tel: +1.781.999.7300
Sales: +1.781.999.7453
Fax: +1.781.280.0668
www.hologic.com

 Europe
(EU Representative)

Hologic NV
Leuvensesteenweg 250A
1800 Vilvoorde, Belgium
Tel: +32.2.711.4680
Fax: +32.2.725.2087

Manufacturer

36-37 Apple Ridge Road
Danbury, CT 06810 USA



Refer to the corporate website for more facilities worldwide.

© Copyright Hologic 2013. All rights reserved. Printed in USA. This manual was originally written in English.

Hologic and the Hologic Logo are trademarks or registered trademarks of Hologic, Inc. Other trademarks registered or used by Hologic and its divisions and subsidiaries in the United States and other countries include: Affirm, ATEC, C-View, Dimensions, DSM, Eviva, FAST Paddle, Hologic Connect, HTC, M-IV, MultiCare, Selenia, Smart Paddle, StereoLoc, TechMate, and Trident. Any other product and company names mentioned herein are the trademarks or registered trademarks of their respective owners.

Table of Contents

List of Figures	vii
List of Tables	ix
1: Introduction	1
1.1 Intended Use.....	1
1.2 Intended Use for the User Guide.....	1
1.3 Product Complaints.....	1
1.4 Technical Support.....	1
1.5 Quality Control.....	1
1.6 Installation Instructions.....	1
1.7 User Profiles.....	2
1.7.1 Mammography Technologist.....	2
1.7.2 Radiologists, Surgeons.....	2
1.7.3 Medical Physicist.....	2
1.8 Training Requirements.....	3
1.9 Terms and Definitions.....	3
1.10 International Symbols.....	4
1.11 Warnings, Cautions, and Notes.....	5
2: General Information	7
2.1 System Description.....	7
2.2 How to Handle the Biopsy Guidance Module.....	8
2.3 Biopsy Guidance Module Components.....	9
2.4 Biopsy Control Module Components.....	10
2.5 Safety.....	11
2.6 Warnings and Precautions.....	11
2.7 Compliance Information.....	13
2.7.1 Requirements.....	13
2.7.2 Label Locations.....	13
3: How to Install or Remove the System	15
3.1 Installation of Components.....	15
3.1.1 How to Attach the Biopsy Guidance Module.....	15
3.1.2 How to Attach the Biopsy Control Module.....	16
3.2 Installation and Removal of Accessories.....	18
3.2.1 Biopsy Compression Paddles.....	18
3.2.2 Biopsy Device Holder.....	18
3.2.3 Needle Guides.....	19
3.2.4 Affirm Table-top Stand.....	20
3.3 Removal of Main Components.....	21
3.3.1 Biopsy Control Module.....	21
3.3.2 Biopsy Guidance Module.....	21

Affirm User Guide

Table of Contents

4: How to Use the System	23
4.1 System Verifications	23
4.1.1 Confirm the Host Connection	23
4.1.2 The QAS Test	23
4.2 Biopsy Control Module Screens	26
4.2.1 Home Screen	26
4.2.2 Target Guidance Screen	26
4.2.3 Jog Mode Screen	30
4.2.4 Select Target Screen	32
4.3 Selenia Dimensions	33
4.3.1 Biopsy Views	33
4.3.2 C-Arm Stereo Modes	35
4.3.3 Biopsy Tab	38
4.3.4 Stereotactic Lesion Targeting	41
4.3.5 Lesion Targeting with Tomosynthesis	42
4.3.6 Post Biopsy	43
4.3.7 Printing Stereo Images	43
5: Care and Cleaning	45
5.1 General Information	45
5.2 Preventive Maintenance Schedule	45
5.3 For General Cleaning	46
5.3.1 How to Clean the Biopsy Control Module Screen	46
5.3.2 To Prevent Possible Injury or Equipment Damage	47
5.4 Geometry Calibration	47
5.4.1 Geometry Calibration Procedure	47
6: Troubleshooting	49
6.1 Audible Alerts	49
6.2 Error Messages	50
Appendix A: System Specifications	51
A.1 Affirm Measurements	51
A.2 Biopsy Guidance Module	51
A.3 Biopsy Control Module	51
Appendix B: Forms	53
B.1 QAS Test Checklist	53
Appendix C: CNR Correction for Biopsy	55
C.1 CNR Correction for Stereotactic Biopsy	55
C.1.1 AEC Table 0 (Standard Stereotactic Biopsy Dose)	55
C.2 CNR Correction for Biopsy Under Tomosynthesis Option	55
C.2.1 AEC Table 0 (Tomosynthesis Option: Standard Tomo Dose)	55
Index	57

List of Figures

Figure 1: Affirm on the Selenia Dimensions	7
Figure 2: How to Lift the Biopsy Guidance Module	8
Figure 3: How to Store the Biopsy Guidance Module	8
Figure 4: Biopsy Guidance Module	9
Figure 5: Biopsy Control Module	10
Figure 6: Label Location	13
Figure 7: Installation of the Biopsy Guidance Module	15
Figure 8: Attachment of the Biopsy Control Module	16
Figure 9: How to Install the Needle Guides	19
Figure 10: Affirm Table-top Stand	20
Figure 11: Home Screen on the Biopsy Control Module	23
Figure 12: Admin Screen	24
Figure 13: Device Field in the Biopsy Tab	24
Figure 14: The Home Screen	26
Figure 15: Target Guidance Screen	27
Figure 16: Green Differential Cells	28
Figure 17: Yellow and Red Cells	28
Figure 18: Alert Sounds are Audible	29
Figure 19: Alert Sounds are Muted	29
Figure 20: Jog Mode Screen	31
Figure 21: Select Target Screen	32
Figure 22: Add a Biopsy View Screen	33
Figure 23: Edit Biopsy View Screen	34
Figure 24: Stereo Mode	36
Figure 25: C-Arm Mode	36
Figure 26: System Status Icon	37
Figure 27: System Status Menu	37
Figure 28: System Defaults Screen	37
Figure 29: The Biopsy Tab	38
Figure 30: Slice Indicator	38
Figure 31: Function Buttons and Data on the Biopsy Tab	39
Figure 32: Stereo Pair Print Screen	43

List of Tables

Table 1: Components of the Biopsy Guidance Module9

Table 2: Components of the Biopsy Control Module.....10

Table 3: How to Use the **Sound** Button29

Table 4: The C-Arm Stereo Mode Button36

Table 5: How to Select the C-Arm Stereo Mode37

Table 6: Radiologic Technologist Preventive Maintenance Schedule.....45

Table 7: Affirm Audible Alerts49

Table 8: Affirm Error Messages50

Chapter 1: Introduction

1.1 Intended Use

R_x Only United States federal law restricts this device to use by, or on the order of, a physician.

The Affirm™ breast biopsy guidance system is an optional accessory for the Selenia® Dimensions® digital mammography system. Its function is to localize lesions accurately in the breast in three dimensions. It is intended to provide targeting guidance for interventional procedures such as biopsy, presurgical localization, or treatment devices.

1.2 Intended Use for the User Guide

Always refer to the User Guide for instructions on using the system.

1.3 Product Complaints

Report any complaints or problem in the quality, reliability, safety, or performance of this product to Hologic. If the device has caused or added to patient injury, immediately report the incident to Hologic. (See the title page for contact information.)

1.4 Technical Support

Refer to the title page of this manual for contact information for product support.

1.5 Quality Control

Facilities that are ACR accredited must follow the 1999 Stereotactic Breast Biopsy Quality Control Manual. Facilities that are not ACR accredited can follow the above manual or perform the QAS Test described in this manual at the required interval.

1.6 Installation Instructions

Installation instructions are available in the Service Manual.

1.7 User Profiles

1.7.1 Mammography Technologist

- Meets all requirements that apply to the location in which the Mammography Technologist operates.
- Completed training on the mammography system.
- Has training in mammography positions.
- Knows about Stereotactic breast biopsy procedures.
- Knows how to operate a computer and its peripherals.
- Can lift 20 pounds to shoulder height with two hands (necessary for upright stereotactic systems).
- Understands sterile procedures.

1.7.2 Radiologists, Surgeons

- Meets all requirements that apply to the location in which the Physician operates.
- Knows about Stereotactic breast biopsy procedures.
- Knows how to operate a computer and its peripherals.
- Understands sterile procedures.
- Gives local anesthesia.
- Knows about basic surgical procedures for core biopsy.

1.7.3 Medical Physicist

- Meets all requirements that apply to the location in which the Medical Physicist operates.
- Knows about mammography.
- Has experience with digital imaging.
- Knows how to operate a computer and its peripherals.

1.8 Training Requirements

In the United States, users must be Registered Radiologic Technologists meeting criteria to perform mammography. The mammography users must meet all applicable MQSA personnel requirements under FDA guidelines for conventional and digital mammography.

The user has options available for training, which include but are not limited to:

- Onsite applications training by a Hologic Clinical Services Specialist
- Onsite on the job training also known as peer training

Additionally, the user manual is a guide for directions on how to use the system.

All users must make sure that they receive training on correct operation of the system before use on patients.

Hologic does not accept the responsibility for injury or damage from wrong system operation.

1.9 Terms and Definitions





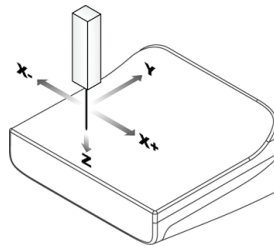

Affirm	The breast biopsy guidance system for the Selenia Dimensions
Biopsy Control Module	The user control device for the Affirm breast biopsy guidance system
Biopsy Guidance Module	Holds and operates the biopsy device. Responds to commands from the Biopsy Control Module to move the device into position and do the biopsy.
Comm	Communication
Diff	Differential
C-Arm Mode	Lets the C-arm and Tube Arm to move together to the Needle Approach angle for the Localization procedure.
Exposure Technique	Combination of x ray parameters (kVp, mAs, filter) for an acquired image
Needle Approach Angle	The angle of incidence of the needle to the breast
QAS	Quality Assurance Standard
Safety Margins	The minimum space allowed between the biopsy device needle that is installed and components of the Selenia Dimensions system.
Stereo Mode	Lets the Tube Arm rotate for acquisition of stereotactic images while the C-arm stays in position.
Stereotactic Procedure	A type of examination that allows stereotactic views at the Acquisition Workstation.
Stereotactic View	A specialized image view that causes the application to capture a stereotactic images.
Stroke Margin	The safety margin (in mm) that remains between the fired needle position and the breast platform.

Tomosynthesis	An imaging procedure which combines a number of projections taken at different angles. The tomosynthesis images can be reconstructed to show focal planes (slices) within the object (Tomosynthesis option).
View	The combination of one x-ray image and a specified set of conditions for image acquisition.
X-axis	<ul style="list-style-type: none"> The (lateral) axis from left to right across the biopsy window
Y-axis	<ul style="list-style-type: none"> The (longitudinal) axis from front to back above the biopsy window
Z-axis	<ul style="list-style-type: none"> The (vertical) axis through the biopsy window



1.10 International Symbols

This section describes the International Symbols on this system.

	Potential Equalization terminal
	Protective Earth terminal
	"On" and "Off" (power) for the computer and display.
	Discard electrical and electronic equipment separately from standard waste. Send decommissioned material to Hologic or contact your service representative.
	Manufacturer
	Date of Manufacture

1.11 Warnings, Cautions, and Notes

Descriptions of Warnings, Cautions, and Notes used in this manual:



WARNING!

The procedures that you must follow accurately to prevent possible dangerous or fatal injury.



Warning:

The procedures that you must follow accurately to prevent injury.



Caution:

The procedures that you must follow accurately to prevent the damage to equipment, loss of data, or damage to files in software applications.



Note

Notes show additional information.

Chapter 2: General Information

2.1 System Description

The Affirm attaches to the Selenia Dimensions. A biopsy device attaches to the Affirm. X- and Y-axis motors in the Affirm move the biopsy device left or right and forward or back. Z-axis movement is manual. The Affirm Biopsy system has two main components:

- Biopsy Guidance Module
- Biopsy Control Module

The Tube Arm on the Selenia Dimensions moves separately from the Compression Arm to allow the acquisition of stereotactic images for the procedure. Refer to the Selenia Dimensions *User Guide* for complete information about that system.

Affirm licensing displays on the Acquisition Workstation screen as "Stereo Licensed". Refer to Licensing Setup in System Tools of the Operating System.

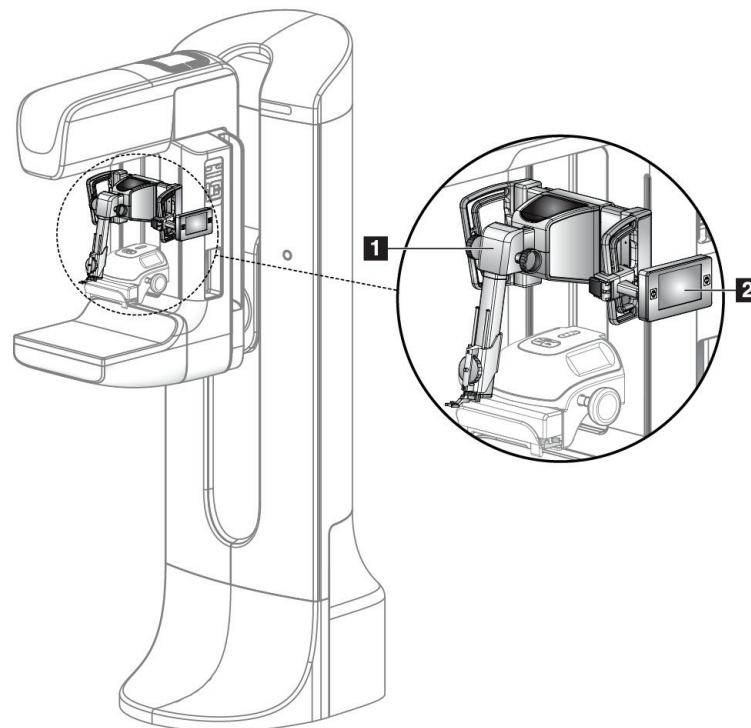

Figure 1: Affirm on the Selenia Dimensions

Figure Legend

1. Biopsy Guidance Module
2. Biopsy Control Module

2.2 How to Handle the Biopsy Guidance Module



Caution:

To prevent damage or alignment problems with the Needle Guidance Stage, be careful when you move the Biopsy Guidance Module.



Caution:

The Affirm Biopsy Guidance Module weighs 15 pounds. When you move it, be sure to have a secure grip on the handles.

- Only lift the Biopsy Guidance Module with the handles.

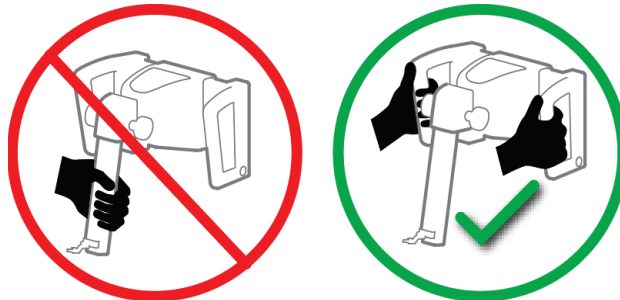

Figure 2: How to Lift the Biopsy Guidance Module

- When the Biopsy Guidance Module is not in use, put the device on its back.

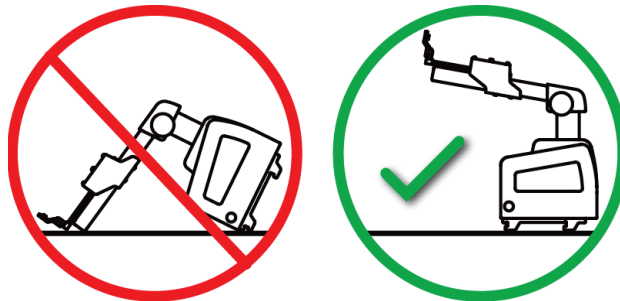

Figure 3: How to Store the Biopsy Guidance Module

2.3 Biopsy Guidance Module Components

The Biopsy Guidance Module installs on the front of the Selenia Dimensions. A lock lever (item 8) secures this module in position. A cable (item 7) connects to the Selenia Dimensions for operation of the biopsy guidance system.

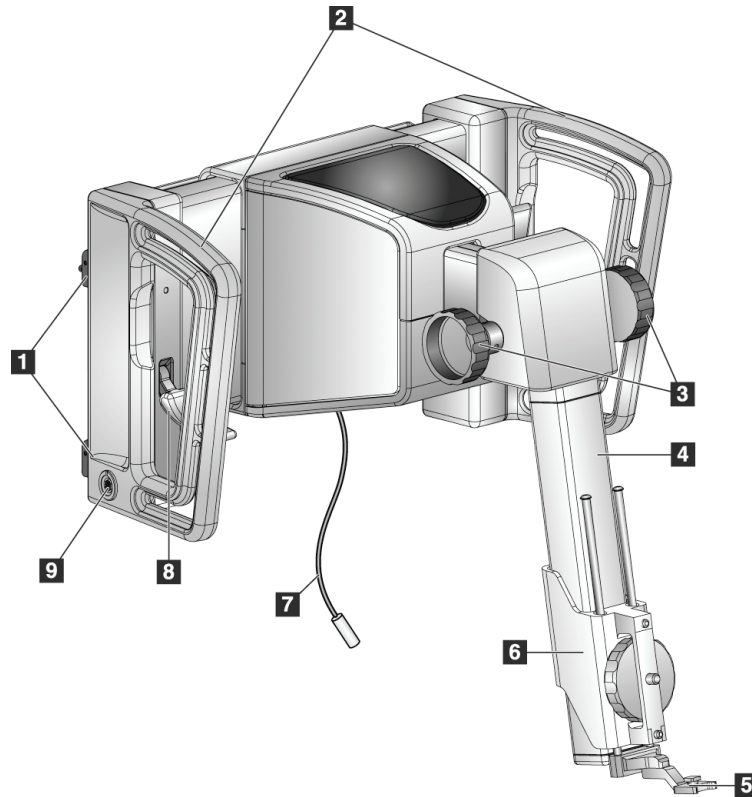

Figure 4: Biopsy Guidance Module

Table 1: Components of the Biopsy Guidance Module

#	Name	Description
1	Attachment Hooks	Two on each side hold the Biopsy Guidance Module on the Selenia Dimensions gantry.
2	Handles	One on each side. Hold both handles to lift the Biopsy Guidance Module.
3	Z-axis Control Knobs	Rotate either knob to move the biopsy device along the Z-axis.
4	Z-axis Slide Rail	Holds the biopsy device holder and provides the track for Z-axis movements.
5	Front Needle Guide	Attaches to the Needle Guide Mount on the Biopsy Device Holder.
6	Biopsy Device Holder	Holds the biopsy device. Moves along the Z-axis Slide Rail when a Z-axis Control Knob is rotated.
7	Cable	Connects to Selenia Dimension to bring power to the Affirm.
8	Lock Lever	One on each side. Engage both levers to lock the Biopsy Guidance Module in position and on the Selenia Dimensions gantry.
9	Receptacle	Accepts the cable from the Biopsy Control Module.

2.4 Biopsy Control Module Components

The Biopsy Control Module attaches to either the left or right handle on the Biopsy Guidance Module with a bracket (item 5). The display screen (item 2) is a touch screen for the user to perform the desired tasks. Motor Enable buttons (item 3) on either side of this module (and at the rear) activate motorized movement of the biopsy device.

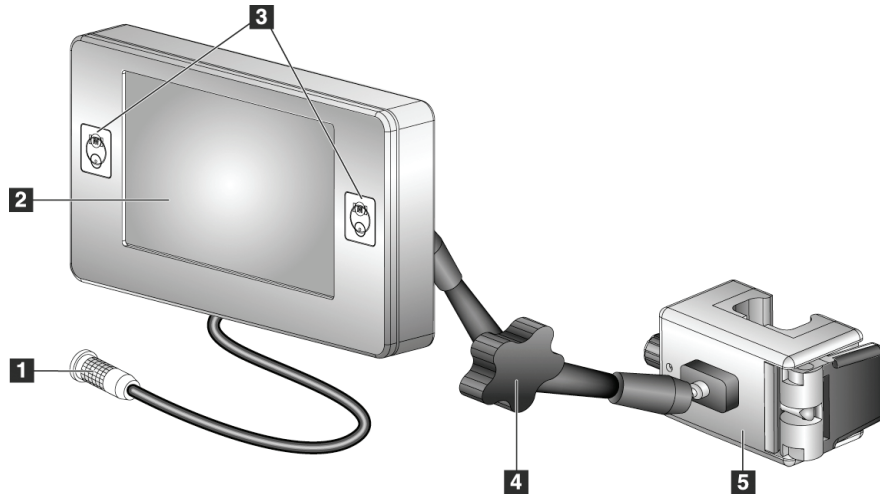

Figure 5: Biopsy Control Module

Table 2: Components of the Biopsy Control Module

#	Name	Description
1	Cable	Connects to Biopsy Guidance Module.
2	Display Screen	Shows targets, system status, name of the biopsy device, and safety margins. Touch buttons allow option selection.
3	Motor Enable Buttons	Front and back button pairs on either side of the display. Press the front and back buttons of either side at the same time to activate a motor movement.
4	Articulating Arm Lock and Release	Rotate to release the lock and adjust the module. Rotate in the opposite direction to lock the arm and hold the module in the new position.
5	Attachment Bracket	Attaches to either handle of the Biopsy Guidance Module.

2.5 Safety

Read and understand this manual before you use the system. Keep this manual available during the patient exams.

Always follow all the instructions in this manual. Hologic does not accept the responsibility for injury or damage from wrong system operation. Hologic can arrange for training at your facility.

The system has protective devices, but the Technologist must understand how to safely use the system. The Technologist must remember the health hazards of x rays.

Do not connect this equipment to any system or component not described in this manual. A combination of components must have the data to validate the safety of the patient, personnel, and the environment. Any additional certification becomes the responsibility of the user.

2.6 Warnings and Precautions



WARNING!

After power failure, remove the patient from the system before you apply power.



Warning:

You make x rays when you use the procedures in this manual.



Warning:

C-arm movement is motorized.



Warning:

The Tube Arm movement is motorized.



Warning:

Only qualified users can use this system.



Warning:

Do not use this equipment if any faults or problems are detected



Warning:

The user must prepare for preventive maintenance by an approved servicing engineer.

Affirm User Guide

Chapter 2: General Information



Warning:

The user or a servicing engineer must correct problems before the system is used.



Warning:

Do not leave the patient unattended during the exam.



Warning:

Keep the hands of the patient away from all buttons and switches at all times.



Caution:

To prevent damage or misalignment, be careful when you move the Affirm.



Caution:

The Affirm Biopsy Guidance Module weighs 15 pounds. When you move it, be sure to have a secure grip on the handles.



Note

The system does not have any parts that are serviced by the user.

2.7 Compliance Information

2.7.1 Requirements

The manufacturer is responsible for the effects of safety, reliability, and performance of this equipment, with the following provisions:

- The equipment is used in accordance with the *User Guide*.
- Assembly operations, extensions, re-adjustments, modifications, or repairs are performed by authorized persons only.

2.7.2 Label Locations

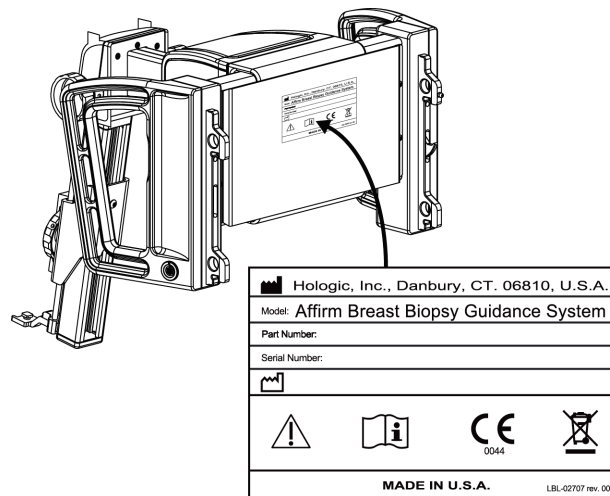

Figure 6: Label Location

Chapter 3: How to Install or Remove the System

3.1 Installation of Components

3.1.1 How to Attach the Biopsy Guidance Module

You can install the Biopsy Guidance Module with the Selenia Dimensions power on or off.



Caution:

To prevent damage or alignment problems with the Needle Guidance Stage, be careful when you move the Biopsy Guidance Module.



Caution:

The Affirm Biopsy Guidance Module weighs 15 pounds. When you move it, be sure to have a secure grip on the handles.

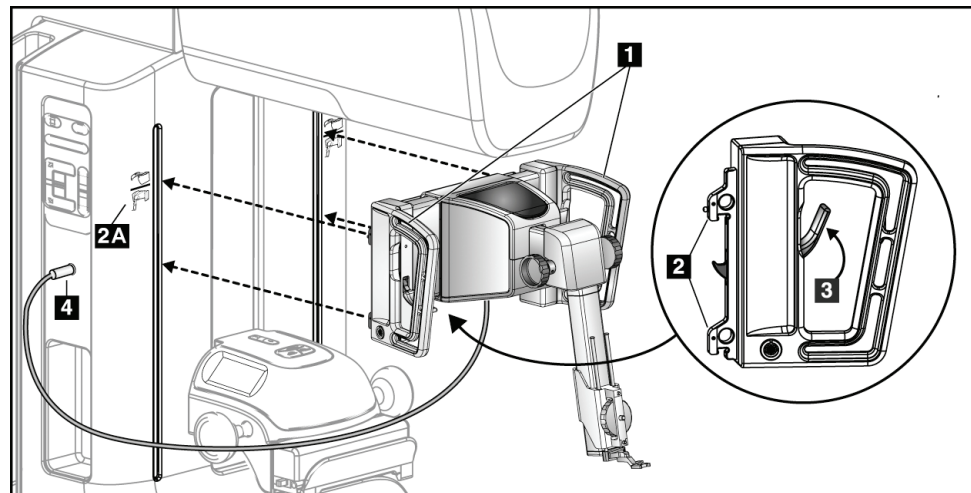

Figure 7: Installation of the Biopsy Guidance Module

1. Move the Compression Device down.
2. Hold the Biopsy Guidance Module by both handles.
3. Slide the top hooks (item 2) of the Biopsy Guidance Module into the slots marked with the Affirm icon (item 2A) on the front of the Selenia Dimensions gantry. Make sure the top and bottom hooks attach to the Selenia Dimensions gantry.
4. Push the Lock Levers (item 3) on the Biopsy Guidance Module into the Up position to lock the Module against the Selenia Dimensions.
5. Align the red dot on the cable (item 4) from the Biopsy Guidance Module with the red dot on the receptacle on the Selenia Dimensions gantry. Connect the cable to the receptacle.

3.1.2 How to Attach the Biopsy Control Module

The Biopsy Control Module attaches to either the left or right handle on the Biopsy Guidance Module.

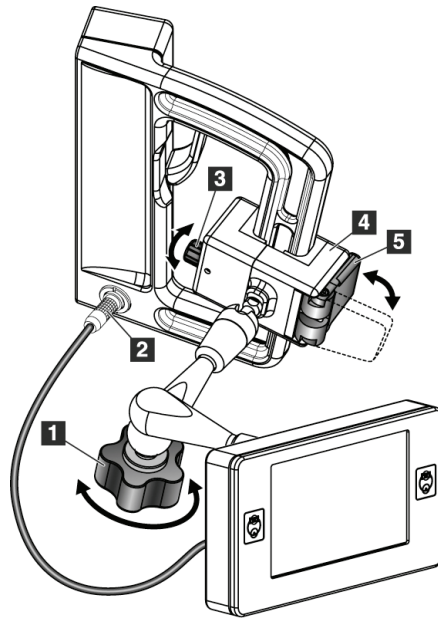

Figure Legend

1. Lock Knob for Articulating Arm
2. Biopsy Control Module Cable
3. Clamp Adjust Knob
4. Attachment Bracket
5. Attachment Bracket Lock

Figure 8: Attachment of the Biopsy Control Module

1. Release the Articulating Arm Lock Knob (item 1).
2. Position the Attachment Bracket (item 4) until the side with the Lock (item 5) is on the front side of the handle.
3. Attach the Lock side of the Attachment Bracket around the lower end of the handle.
4. Slide the opposite side of the Attachment Bracket around the handle. The Bracket attaches on to the patient handle.
5. If necessary, adjust the Clamp Adjust Knob (item 3).
6. Push the Attachment Bracket Lock to the locked position (item 5).
7. Make sure that this adjustment holds the bracket in position. If the bracket moves, or you cannot get the bracket lock completely into the locked position, adjust with the Clamp Adjust Knob (item 3).
8. Connect the Biopsy Control Module Cable (item 2) to the Biopsy Guidance Module.

How to adjust the bracket height

1. Release the Attachment Bracket Lock (item 5).
2. Slide the bracket to the required height.
3. Put the Attachment Bracket Lock (item 5) into the locked position.

How to adjust the Biopsy Control Module position

1. Release the Lock Knob (item 1) for the Articulating Arm.
2. Tilt or change the current angle of the Biopsy Control Module.
3. Turn the Lock Knob (item 1) to lock the Biopsy Control Module in the new position.

3.2 Installation and Removal of Accessories

3.2.1 Biopsy Compression Paddles

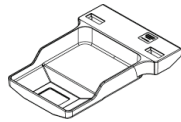

5x5 cm
Standard Biopsy
Paddle

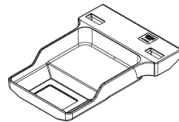

6x7 cm
Standard Biopsy
Paddle

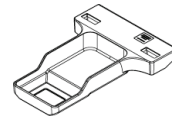

5x5 cm
Axillary Biopsy
Paddle

The biopsy compression paddles attach to the compression device on the Selenia Dimensions. Refer to the *Selenia Dimensions User Guide* for instructions on installation and removal of the paddles.

3.2.2 Biopsy Device Holder

To install a biopsy device holder:

1. Align the holes (top and bottom) in the holder with the guide pins on the mount.
2. Align the center hole with the mount screw.
3. Turn the thumbwheel on the mount to attach the device holder.

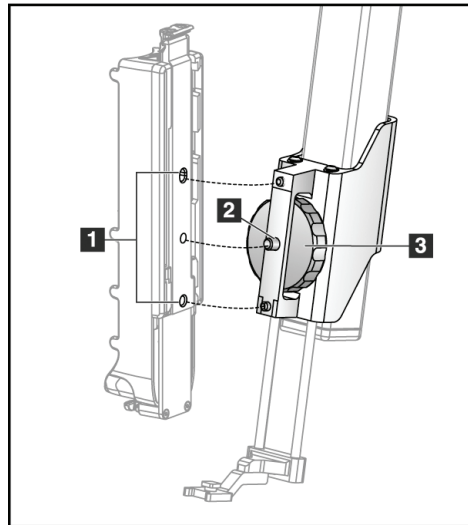

Figure Legend

1. Biopsy Device Holes
2. Mount Screw
3. Thumbwheel

To remove a biopsy device holder:

1. Turn the thumbwheel on the mount to release the device holder.
2. Remove the device holder from the mount.

3.2.3 Needle Guides

**Warning:**

Always use sterile techniques when you use Needle Guides during the patient procedures.

**Warning:**

It is important to install the device correctly. Be sure to insert the needle through the top and bottom Needle Guides.

To install a disposable Needle Guide:

1. Align the Needle Guide so that the raised-square side of the Needle Guide fits between the two lobes of the Needle Guide Mount.
2. Slide the open area of the U-shape in the Needle Guide around the pin in the Needle Guide Mount.
3. Push the Needle Guide in until it locks into position.

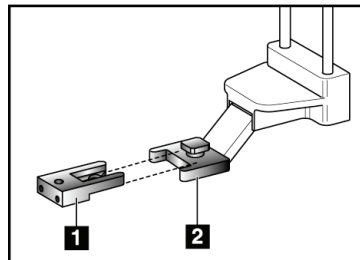

Figure 9: How to Install the Needle Guides

Figure Legend

1. Needle Guide
2. Needle Guide Mount

**Note**

The Needle Guides can look different from the Needle Guide shown.

To remove a disposable Needle Guide:

1. Remove the biopsy device from the Z-axis Slide Rail.
2. Pull the Needle Guide away from the pin and remove from the Needle Guide Mount.
3. Discard the Needle Guide in accordance with local regulations.

3.2.4 Affirm Table-top Stand



Caution:

The Affirm Table-top Stand is not applicable to mobile applications.

To place the Affirm on the optional stand, refer to the following figure.

1. Move the Affirm Biopsy Device Holder and needle guide to the highest upper position as shown in **A**.
2. Disconnect the Affirm cable from the Gantry.
3. Remove the Affirm Guidance Module along with the Control Module, if present.



Caution:

To prevent damage or alignment problems with the Needle Guidance Stage, be careful when you move the Biopsy Guidance Module.



Caution:

The Affirm Biopsy Guidance Module weighs 15 pounds. When you move it, be sure to have a secure grip on the handles.

4. Place the Affirm on the Table-top Stand as shown in **B**.

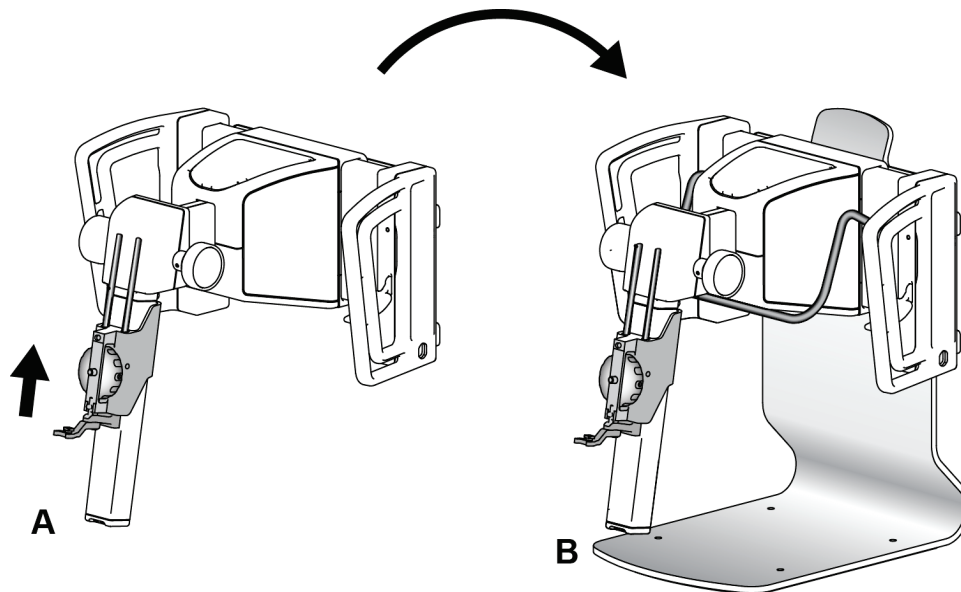

Figure 10: Affirm Table-top Stand

3.3 Removal of Main Components

3.3.1 Biopsy Control Module

To remove the Biopsy Control Module from the Biopsy Guidance Module:

1. Disconnect the cable of the Biopsy Control Module from the Biopsy Guidance Module.
2. Release the bracket lock.
3. Remove the Biopsy Control Module from the Biopsy Guidance Module.
4. Store the Biopsy Control Module in a protected location.

3.3.2 Biopsy Guidance Module

To remove the Biopsy Guidance Module from the Selenia Dimensions:

1. Disconnect the Biopsy Guidance Module Cable from the Selenia Dimensions.
2. Hold a handle of the Biopsy Guidance Module with one hand while you release the Locking Levers with the other hand.
3. Put a hand on each handle and lift the Biopsy Guidance Module from the slots in the Selenia Dimensions.
4. Store the Biopsy Guidance Module in a safe location. Make sure that you put the unit on its back (hooks down).

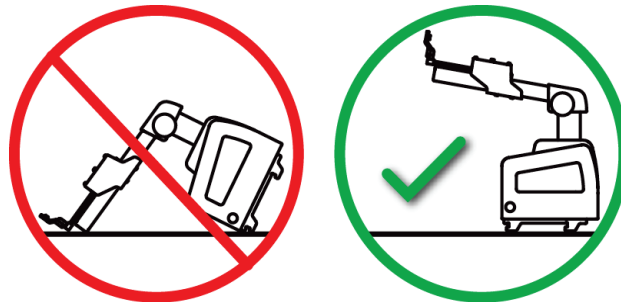

Caution:

To prevent damage or alignment problems with the Needle Guidance Stage, be careful when you move the Biopsy Guidance Module.



Caution:

The Affirm Biopsy Guidance Module weighs 15 pounds. When you move it, be sure to have a secure grip on the handles.

Chapter 4: How to Use the System

4.1 System Verifications

4.1.1 Confirm the Host Connection

When the Selenia Dimensions is On and the Affirm cable connections are correct, the Home screen shows on the Biopsy Control Module.

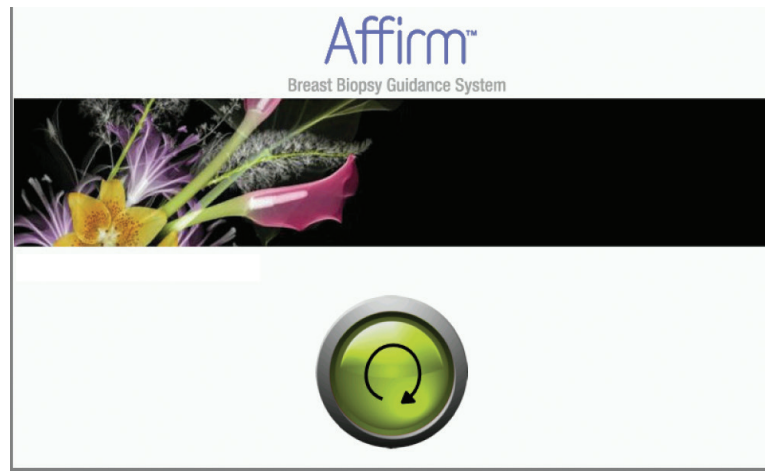

Figure 11: Home Screen on the Biopsy Control Module

4.1.2 The QAS Test

Each day that you plan to use the system, do this test one time to confirm the system accuracy. Record your results in the [QAS Test Checklist](#) on page 53.



Note

You can use Auto C-Arm Stereo Mode or Manual C-Arm Stereo Mode for the QAS Test. For more information about these modes, refer to [C-Arm Stereo Modes](#) on page 35.

The QAS Test

1. Select the **Admin** button on the Selenia Dimensions, then select the **QAS** button from the Admin screen.

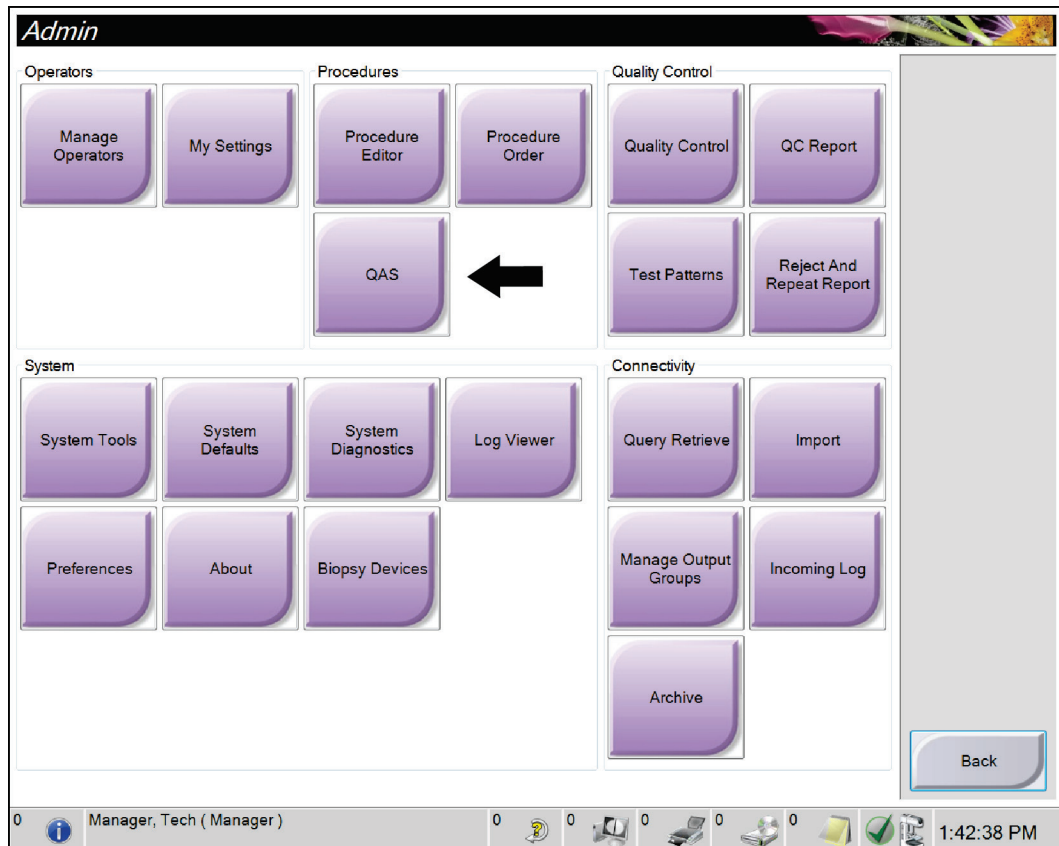

Figure 12: Admin Screen

2. When the QAS screen shows on the Selenia Dimensions Acquisition Workstation, select the **Biopsy** tab.
3. Make sure that QAS appears in the Device field.

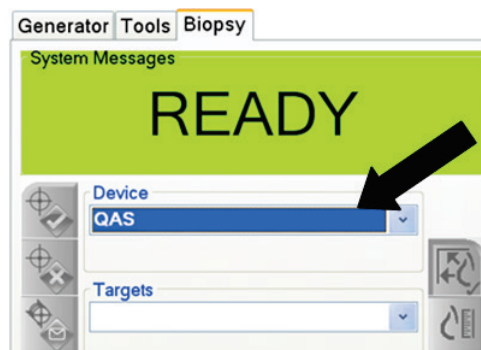

Figure 13: Device Field in the Biopsy Tab

4. Remove the Compression Paddle.
5. Move the compression carriage to between 55 and 65 mm.
6. If the QAS uses a phantom, attach the phantom at the top end of the Z-axis Slide Rail.
If the QAS uses a needle, fully extend the needle.



Caution:

If the QAS uses a needle, do not extend the needle unless it is attached to the Biopsy Guidance Module and the module is installed on the C-arm.

7. Press and hold a right or left **Motor Enable** button pair on the Biopsy Control Module. (The QAS Phantom moves automatically to pre-programmed X and Y positions of 30/40/50.)
8. Turn the Z-axis Control Knob to show 0.0 on the Diff line in all three columns of the Biopsy Control Module.
9. Select **Manual exposure mode, Rhodium filter** in the QAS screen.
 - For QAS Needle use 25 kV, 10 mAs,
 - For QAS Tomo Phantom use 25 kV, 30 mAs
10. **Acquire** and **Accept** the first view in the procedure. The Auto-Accept feature is not enabled during the QAS procedure, and targeting on the QAS Phantom occurs automatically.
11. Select the **Create Target** button to send the target to the Biopsy Control Module. Verify that the target coordinates are within ± 1 mm of X, Y, and Z numbers on the current line of the Biopsy Control Module.



Warning:

If the targeting coordinates are not within ± 1 mm, contact Technical Support. Do not try to adjust the system. Do not perform any biopsy procedure with the Affirm until Technical Support indicates the system is ready for use.



Warning:

The user or a servicing engineer must correct problems before the system is used.

12. Repeat steps 10 and 11 for all unexposed views.
13. Select the **End QC** button on the Acquisition Workstation screen.
14. Press a **Home Position** button (Left or Right) to move the QAS Phantom to the side.
15. Remove the QAS Phantom from the Z-axis Slide Rail.

4.2 Biopsy Control Module Screens

4.2.1 Home Screen

The Home screen shows the name or initials of the user who logs in and any error messages. The Go button takes the user to the Target Guidance screen.

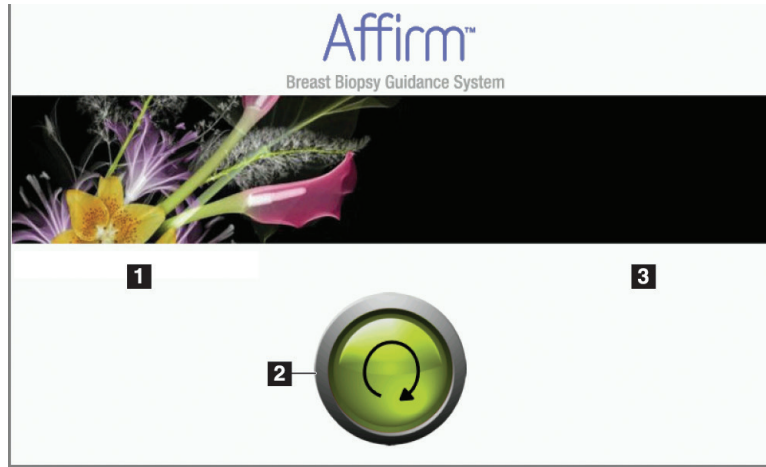

Figure 14: The Home Screen

Figure Legend

1. User ID Area
2. Go Button
3. Error Message Area

4.2.2 Target Guidance Screen

The following figure shows the main screen of the Biopsy Control Module. This screen shows the current position of the biopsy device, the selected target coordinates and the Cartesian difference between the two positions.

The buttons in the Target Guidance screen allow the user to go to the Previous screen (item 3), go to the screen for target selection (item 2), go to the screen for motorized movement of the biopsy device in the X and Y axes (item 1), select the C-Arm Mode or Stereo Mode for the C-arm rotation (item 5), and cancel an audible signal (item 7).

The display area (item 4) of the Target Guidance screen shows the difference between the current position of the biopsy device and the target coordinates, the status of the system (item 10), the biopsy device installed on the system (item 8), and the safety margins (item 9).

(The figure and the figure legend appear on the following page.)

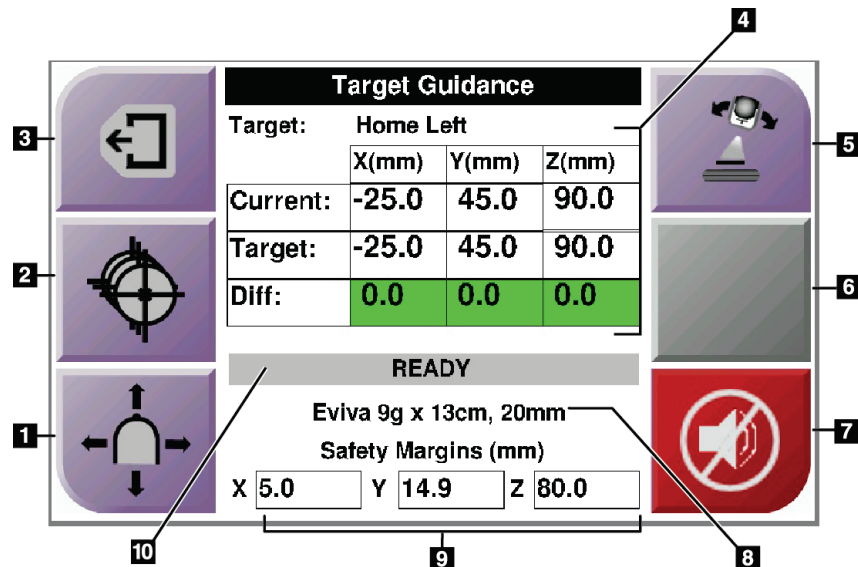

Figure 15: Target Guidance Screen

Figure Legend

1. Go to the Jog Mode screen
2. Go to the Select Target screen
3. Go to the Previous screen
4. Target Information
5. Switch between C-Arm Mode or Stereo Mode (when the system is set for Manual C-Arm Stereo Mode).
6. This button is gray and disabled.
7. Mute or Enable Sound (An icon displays on this button and an alarm sounds when there is a system fault. See [The Sound Button](#) on page 29.)
8. Selected Biopsy Device
9. Safety Margins
10. System Status



Note

The X, Y, and Z cells in the screen can change color as target coordinates change. See [Colored Cells in the Screens](#) on page 28.

Colored Cells in the Screens

Green Cells

When all Diff cells are green, the biopsy device is in the correct position for the selected target. When the biopsy device is fired, the target is at the center of the aperture of the device.

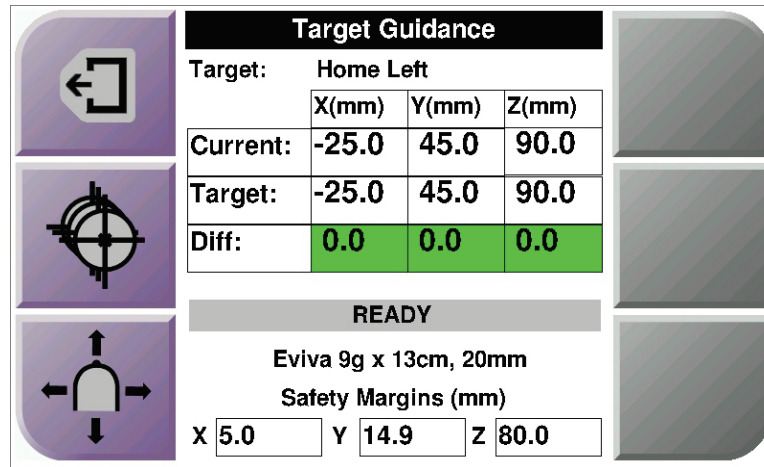

Figure 16: Green Differential Cells

Yellow and Red Cells

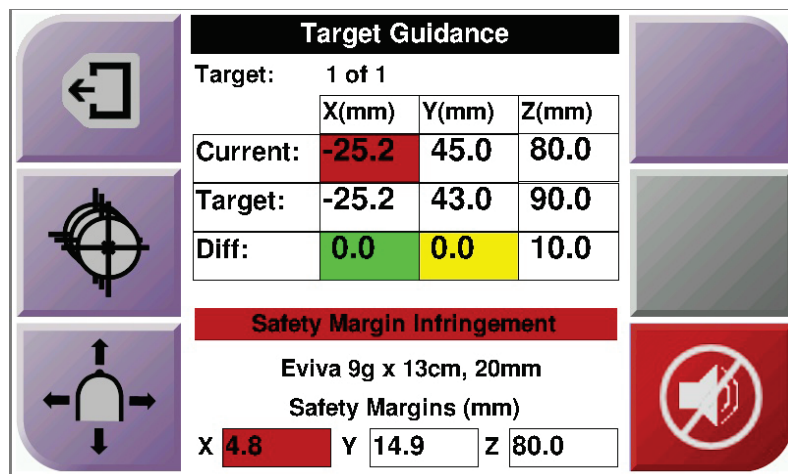



Figure 17: Yellow and Red Cells

- **Yellow** indicates that the biopsy device is in the correct position for that axis, but you must move the device to the final Z-position. When the biopsy device is in the final Z-position, the yellow cell changes to green.
- **Red** indicates a problem with a safety margin. The **Sound** button appears and the system makes repeated beeps. Make adjustment in the axis indicated by red. When the cell is not red, the device is within the safety limits.

The Sound Button

The **Sound** button is enabled when there is a system fault. When the **Sound** button displays, you can control system sounds related to alarms and motor movements of the biopsy device.

*Table 3: How to Use the **Sound** Button*

Sound	
 <p><i>Figure 18: Alert Sounds are Audible</i></p>	<ul style="list-style-type: none"> • When a safety margin is violated, this icon displays and the system repeats a beep sound. • To stop the sound, press the Sound button. All system beep sounds are muted, and the icon on the button changes. • When you correct the safety margin violation, the icon on the button disappears. • If you press the button and do not correct the system fault within two minutes, the system beep sounds are enabled automatically.
 <p><i>Figure 19: Alert Sounds are Muted</i></p>	<ul style="list-style-type: none"> • When this icon appears on the Sound button, you have the option to enable the system beep sounds. • To enable the system beep sounds, press this button. • If you do not press this button, system beep sounds are enabled automatically within two minutes after this icon displays.

4.2.3 Jog Mode Screen

This screen allows the user to manually overwrite the targeting coordinates of the Biopsy Guidance Module. The arrow buttons in the Jog Mode screen change the Jog value of the X and Y coordinates. Other buttons in this screen allow the user to go to the Target Guidance Screen (item 5), and cancel (item 7) an audible signal that sounds when there is a problem with a safety margin.

The display area (item 4) of the Jog Mode screen shows the difference between the current position of the biopsy device and the target coordinates, the status of the system (item 10), the biopsy device installed on the system (item 8), and the safety margins (item 9).



Warning:

Red cells indicate a problem with a safety margin. Patient injury or equipment damage may occur if you continue. Make adjustments to be within safety limits.

(The figure and the figure legend appear on the following page.)

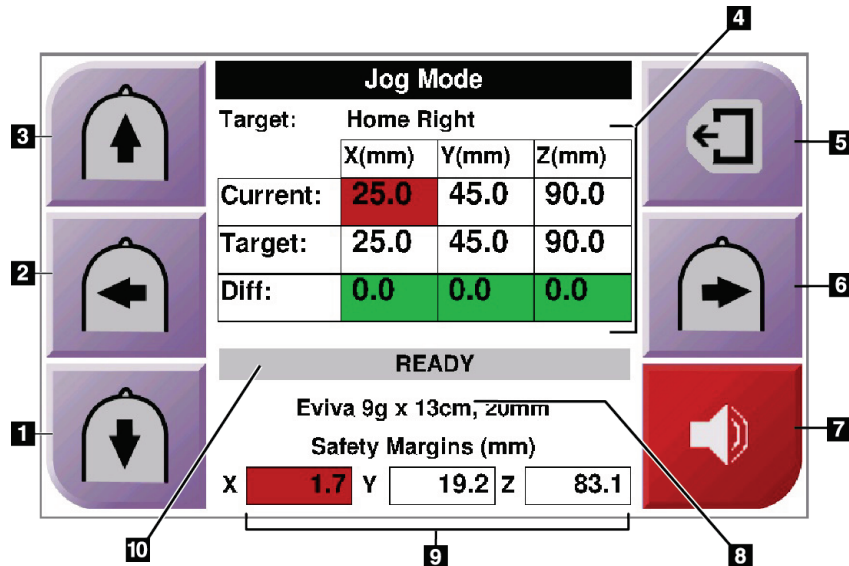

Figure 20: Jog Mode Screen

Figure Legend

1. Change Y-axis Jog value in negative direction
2. Change X-axis Jog value in negative direction
3. Change Y-axis Jog value in positive direction
4. Target Information
5. Go to the Previous screen
6. Change X-axis Jog value in positive direction
7. Mute or Enable Sound (An icon displays on this button and an alarm sounds when there is a problem. See [The Sound Button](#) on page 29 for more information about the Sound button.)
8. Selected Biopsy Device
9. Safety Margins
10. System Status

4.2.4 Select Target Screen

This screen allows the user to select a different target for biopsy guidance or to move to one of the Home positions. The buttons in the Select Target screen allow the user to go to the Previous screen (item 1), go to the Target screen (item 2), or go to the Left or Right Home Position (item 3 or item 6).

The display area (item 4) of the Select Target screen shows one or more sets of target coordinates. The name of the biopsy device that was selected also displays (item 5).

To move the biopsy device to one of the targets shown in this screen:

1. Press one of the target coordinates icons or the home buttons.
The system changes to the Target Guidance screen.
2. Press and hold a right or left **Motor Enable** button pair on the Biopsy Control Module.
The needle moves to the X and Y positions.

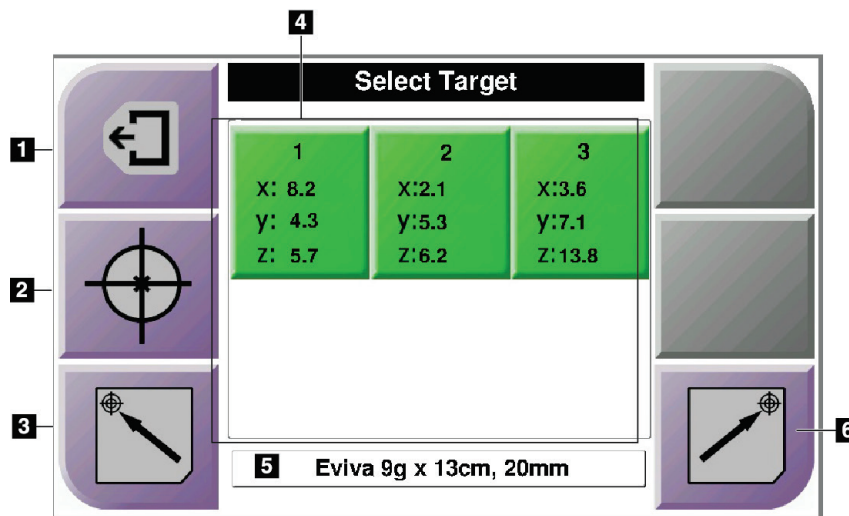

Figure 21: Select Target Screen

Figure Legend

1. Go to the previous screen
2. Go to the Target Guidance screen
3. Go to the Home Left Position
4. Target Coordinates
5. Biopsy Device
6. Go to the Home Right Position



Note

You must simultaneously press both switches of a right or left **Motor Enable** pair to start the motor movement.

4.3 Selenia Dimensions

4.3.1 Biopsy Views

When used with the Selenia Dimensions 2D system, biopsy procedures require stereo views, which are images taken at +15° and -15° angles. Collectively, these images are called a stereo pair. The word "stereo" in the biopsy procedures refers to the +15° and -15° projections.

When used with the Selenia Dimensions 3D system, a 3D tomosynthesis image acquisition is acquired to determine the 3D (X-Y-Z) Cartesian coordinates of the region of interest.

How to Add a Biopsy View

1. From the Procedure screen, select the **Add View** button.

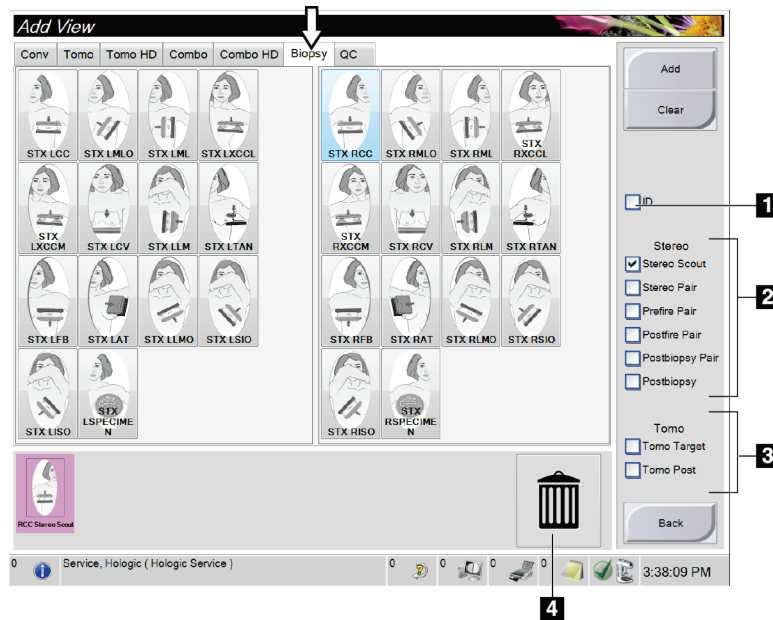

Figure 22: Add a Biopsy View Screen

Figure Legend

1. Implant Displaced
 2. Stereo View Modifiers
 3. Tomographic View Modifiers
 4. Trash Icon
2. Select the Biopsy tab, then select the view to add and the applicable View Modifier.
 3. Select the **Add** button.
- To remove the selected view, select the view then press the Trash icon.



Note

The Biopsy Stereo and Tomographic View Modifiers show only when the system has licenses for tomosynthesis and biopsy.

How to Edit a Stereo View

Use the Edit View screen to assign a different view to an image.

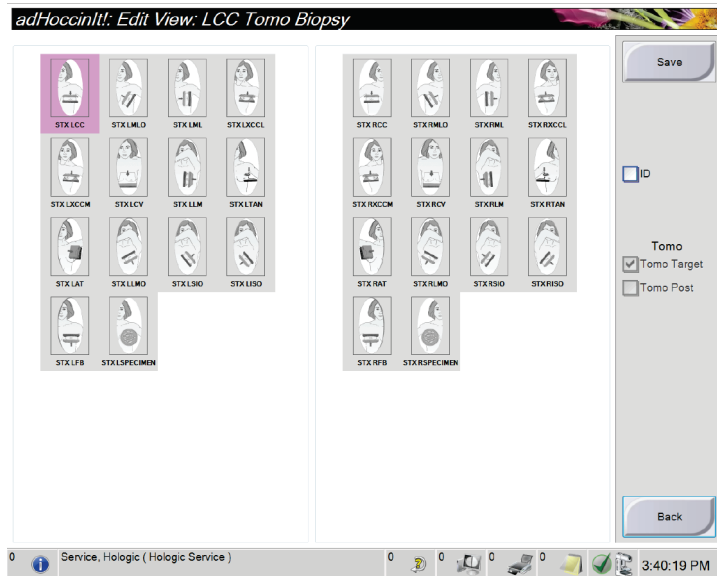

Figure 23: Edit Biopsy View Screen

To edit a view:

1. Select an exposed thumbnail image view in the Procedure screen.
2. Select the **Edit View** button.
3. Select the view from the screen and appropriate View Modifiers from the right side of the screen.
4. Select the **Save** button.
5. When the Update Successful screen displays, select the **OK** button.

4.3.2 C-Arm Stereo Modes

Acquire the stereo images in either the Auto C-Arm Stereo Mode or the Manual C-Arm Stereo Mode. Make the C-Arm Stereo Mode selection at the Acquisition Workstation (refer to [How to Select the C-Arm Stereo Mode for Image Acquisition](#) on page 36).

C-Arm Rotation in the C-Arm Stereo Modes

The mechanics of C-arm rotation for stereotactic image acquisition is different in Auto and Manual C-Arm Stereo Modes.



Note

C-arm vertical movement and rotation are disabled when compression force is applied. A service engineer can configure the lockout force from 22 Newtons (5 pounds) to 45 Newtons (10 pounds).

In Auto C-Arm Stereo Mode

In the Auto C-Arm Stereo Mode, the Target Guidance screen does not show the **C-Arm Stereo Mode** button. In the Auto C-Arm Stereo mode, the system automatically lets the C-arm move separately from the Tube Arm to acquire the stereo images. When the **X-ray** button is pressed to start stereo image acquisition, the Tube Arm automatically moves to the first 15° angle, acquires the image, rotates to the opposite 15° angle and acquires that image.



Note

The option to position the Tube Arm for the first stereo image is in the System Status menu (refer to [How to Select the C-Arm Stereo Mode for Image Acquisition](#) on page 36). The Tube Arm automatically rotates to the selected 15° angle. This option operates in both C-Arm Stereo modes.

In Manual C-Arm Stereo Mode



In Manual C-Arm Stereo Mode, the **C-Arm Stereo Mode** button shows on the Target Guidance screen. The default is Stereo Mode. See the table that follows for a description of the button function.



Note

The C-Arm Stereo Mode button shows when the system is set for Manual C-Arm Stereo Mode. In Auto C-Arm Stereo Mode, this button does not show.

Table 4: The C-Arm Stereo Mode Button

Icon	Description of Function
 <p><i>Figure 24: Stereo Mode</i></p>	<ul style="list-style-type: none"> • The Tube Arm rotates while the C-Arm remains in position. • Select Stereo Mode to acquire stereo images (when the system is set for Manual C-Arm Stereo Mode).
 <p><i>Figure 25: C-Arm Mode</i></p>	<ul style="list-style-type: none"> • The C-arm and Tube Arm rotate together. • Select C-Arm Mode to rotate the C-arm and Tube Arm together to a new patient positioning angle.

1. After you set the patient positioning angle (with the C-Arm Mode engaged), press the **C-Arm Stereo Mode** button on the Target Guidance screen to put the C-arm into Stereo Mode.
2. Rotate the Tube Arm to the first 15° angle.
3. Press the **X-ray** button and acquire the first 15° image.
4. Rotate the Tube Arm to the opposite 15° angle.
5. Press the **X-ray** button and acquire the opposite 15° image.



Note

Keep the **X-ray** button pressed until the exposure stops. An audible beep indicates that image acquisition has finished.

How to Select the C-Arm Stereo Mode for Image Acquisition

Table 5: How to Select the C-Arm Stereo Mode

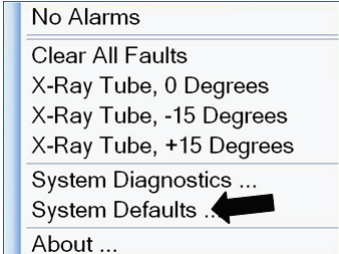
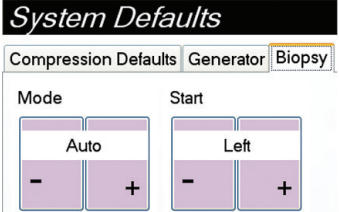
<p>1. Select the System Status icon.</p>	<div style="text-align: center;">  <p><i>Figure 26: System Status Icon</i></p> </div>
<p>2. Select System Defaults from the System Status menu.</p>	<div style="text-align: center;">  <p><i>Figure 27: System Status Menu</i></p> </div>
<p>3. Select the Biopsy tab in the System Defaults screen. 4. Select Auto or Manual from the Mode section.</p>	<div style="text-align: center;">  <p><i>Figure 28: System Defaults Screen</i></p> </div>

4.3.3 Biopsy Tab

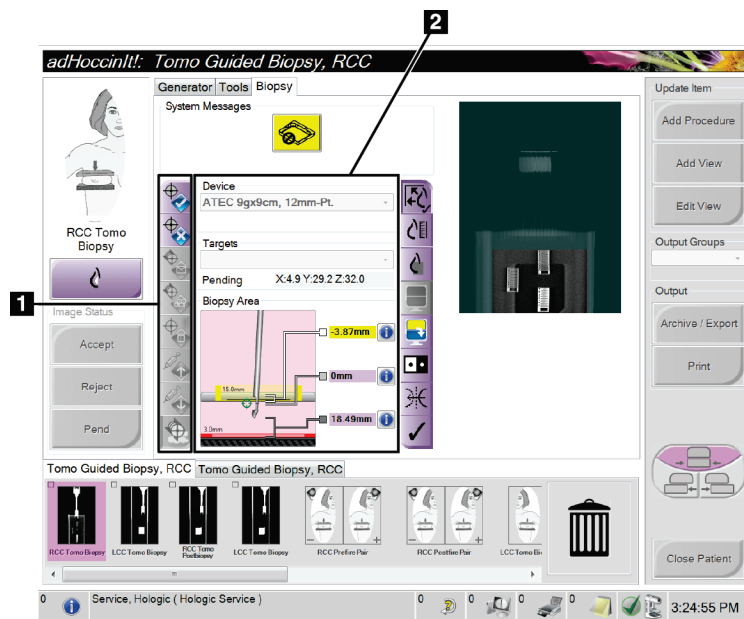

Figure Legend

1. Target Function Buttons
2. Biopsy Staging Area

Figure 29: The Biopsy Tab

When you select the Biopsy tab, the Biopsy screen appears. This middle section of the screen shows information about the targets and the biopsy device installed on the system. The buttons on the left side of this information let you send selected targets to the Biopsy Control Module. See [Biopsy Staging](#) on page 39 for information about the buttons and data fields on the Biopsy tab screen.

Slice Indicator

The Slice Indicator shows only on tomographic reconstructions.

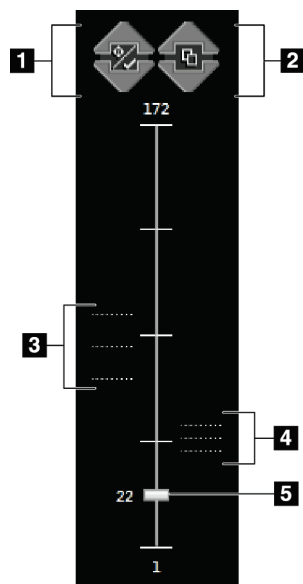

Figure Legend

1. Up and Down arrows let you change between slices that contain a lesion target and slices that are tagged for printing.
2. Up and Down arrows let you change between slices that contain notices.
3. Slices that contain targets or are tagged for printing.
4. Slices that contain notices.
5. Scroll bar moves through the slices of the reconstruction.

Figure 30: Slice Indicator

